



Alucast Iran Co.

Since 1977

Activities

● Power transmission fittings



- Design and engineering
- Production

- ## ● Railway electrification:
- Traction system
 - Overhead catenary
 - Operational plan studies



- Design and engineering
- Production
- Installation
- Supervision

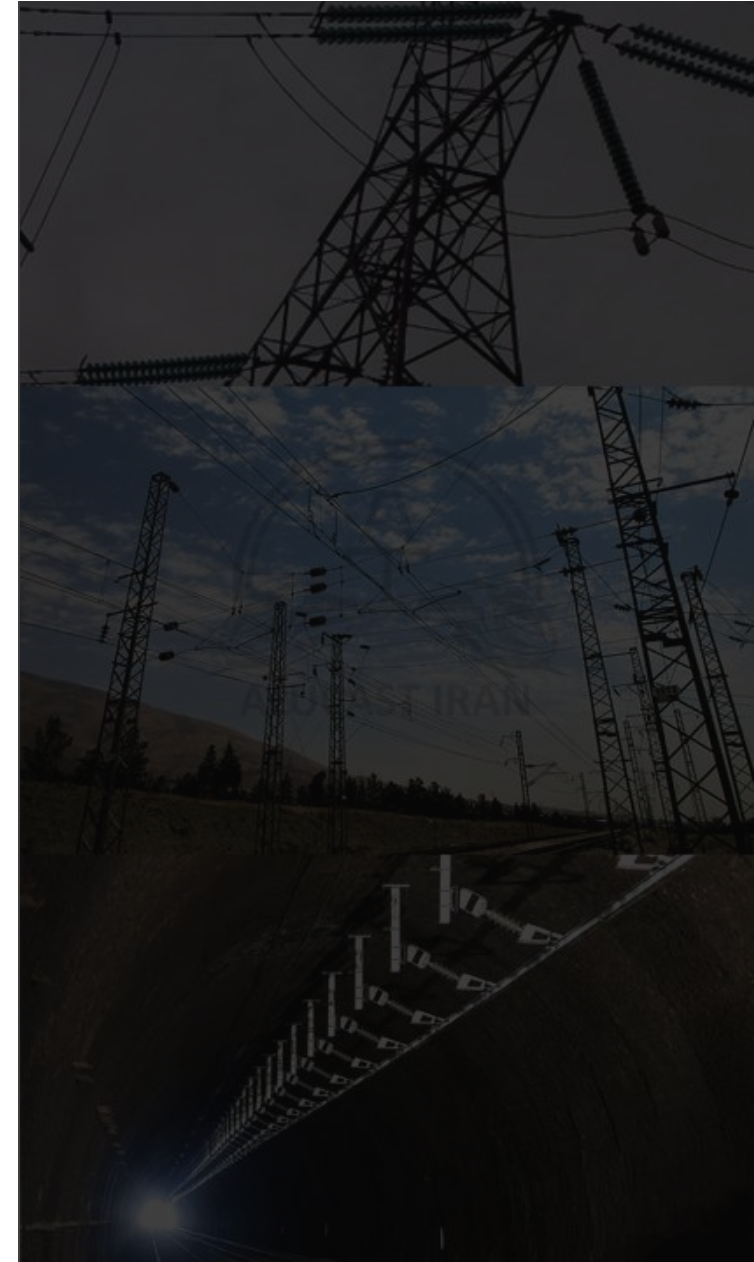

Alucast Iran Company with a history of 40 years, is one of the biggest company in terms of engineering and manufacture of high and mid voltage networks' fittings that technically start to OCS design & manufacturing electrical railway's overhead network fittings, since 1998. Initially, this company start to manufacture spare fittings in order to renew electrical railway overhead network of Tabriz-Jolfa and Tehran subway that gradually covered other subway companies. Respectfully, this company cooperates with companies like; Tehran Urban Railway, Azerbaijan Railway, Mashhad Urban Railway, Shiraz Urban Railway, Tabriz Urban Railway and Tehran Trolley Bus, right now. Respect to major need in development of electrical railway industry's infrastructure in Iran, Alucast Iran company formed and completed its personnel by using professionals in Urban Railway companies, National Subway Companies, Tehran Trolley Bus and bring together young talented engineers and also by cooperating with qualified and experienced Spanish company. By relaying on its experience in manufacturing high-voltage transmission networks, distribution, subway and trolley bus fittings' parts, proceed to participate in railway tenders. So far, we have undertaken engineering, manufacturing, installation and installation supervision project contracts and we are able to engineer, design, manufacture equipment and installation of electrification railway projects.

Due to feeling the need of promotion and implementation in electrical railways of urban and between urban transportation industry. Alucast Iran company announce its readiness to implement railway, subway, trolley bus and tramway projects, according to international standards. We are willing that authorities acknowledge their kind acceptance cooperating and valuable support with this local company that brought this industry to this stage using ability of children of this land.

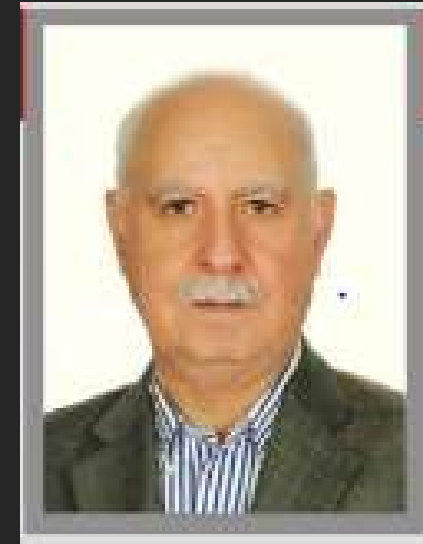

We are relying on the ability of our Experts
Company founder: Akbar Riahi, since 1977

Alucast Iran Brands

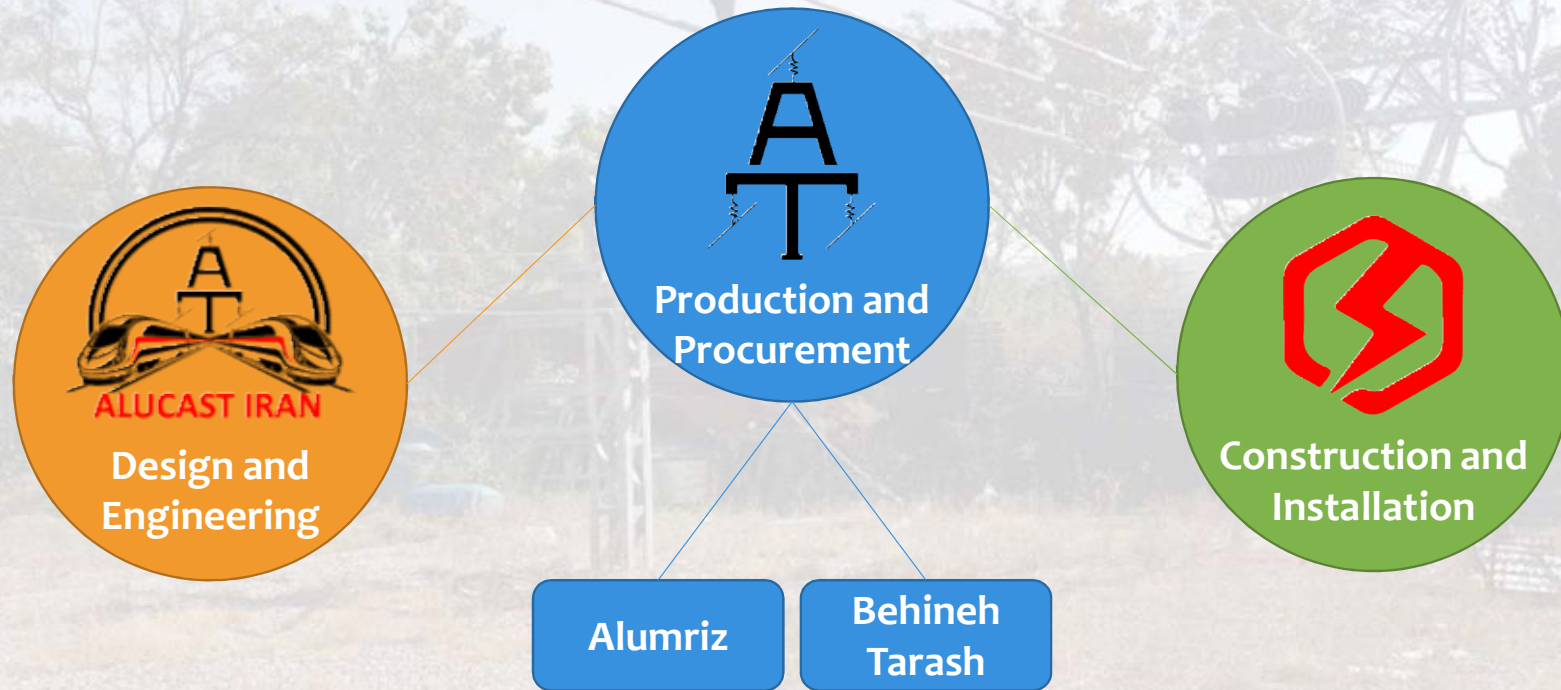

Company and subsidiary companies distribution



Educational Degree and Experiences of Members

Number of personnel: 130

Members educational degree graph

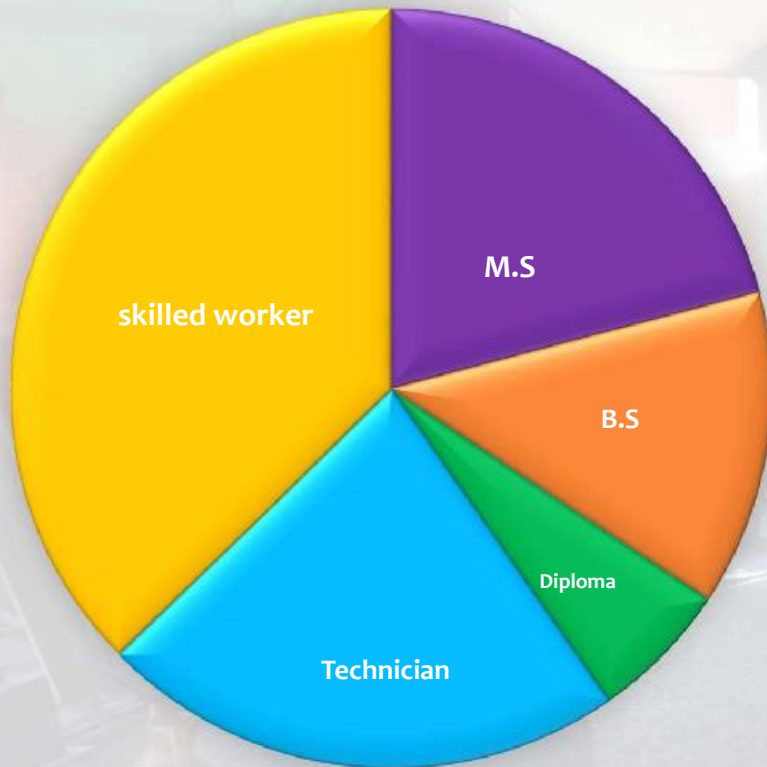

Experince graph of staff

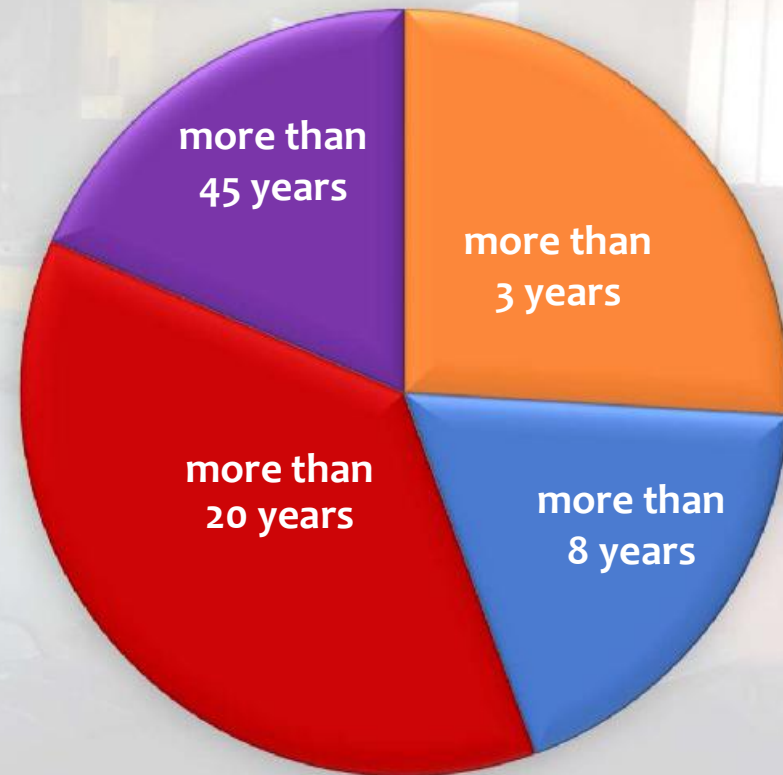

Alucast Iran Co.

Engineering Units



Electrical Engineering Unit

Electrical R&D team is divided into three subunits that consists of power electronics, power system and power system protection. Respect to knowledge variety of electrical unit, this team is able to cover every related subjects to electrical railway and solve its problems. Calculation of system elements and elements sizing is one of the most important aspects in electrical railway. This calculation should be done considering every possible situation such as errors and transients. This should be noted that without using accurate calculations with the use of exact model of the system and consideration of environmental condition and system headway that is being operated using Alucast Iran local software, selection of equipment and demanded power from network will be impossible. Using calculations and national and international standards in order to selection of appropriate equipment respect to environmental condition and utilization of the system that can be achieved using recent science and experience. In Alucast Iran company, electrical team provide link among other groups, company's manager and manager of the project. In addition to aforementioned cases, it's necessary for electrical engineers to consider environmental matters in order to prevent irreparable damages.

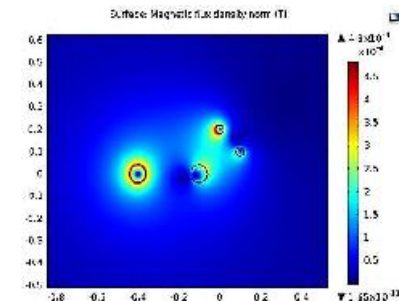
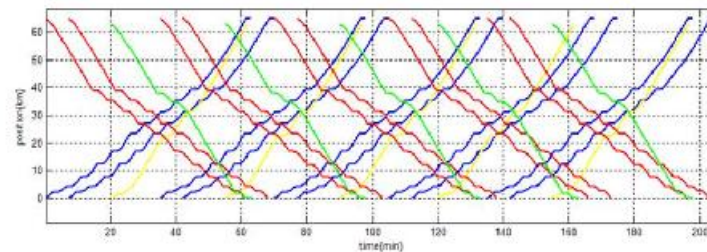

Engineering Units



Mechanical Engineering Unit

Mechanical engineering department activities are concentrated on overhead networks' static and dynamic simulations. Designed fitting and equipment are tested and simulated in numerical simulation software in order to verify bearing of the equipment, considering boundary and loading conditions. Numerical analysis role being highlighted when there isn't any suitable testing feature for large equipment. By using numerical analysis and considering convenient input condition reliable results are achievable. Preforming all of the mechanical calculations in each parts of the line will lead to complete mastery over dynamic and static forces in order to accord simulations and experimental tests with reality. Commercial analytical software as a powerful tool provide possibilities for optimizing fittings, equipment and structures in order to save human cost, financial cost and so on, to achieve optimized design in terms of geometry, material and function. Obtaining experience from operational projects in the field of electrical railway, dynamic research and development, cooperation with oversea consulter companies, absorption of technology and expert manpower has paved the way of electrical railway projects to the team.

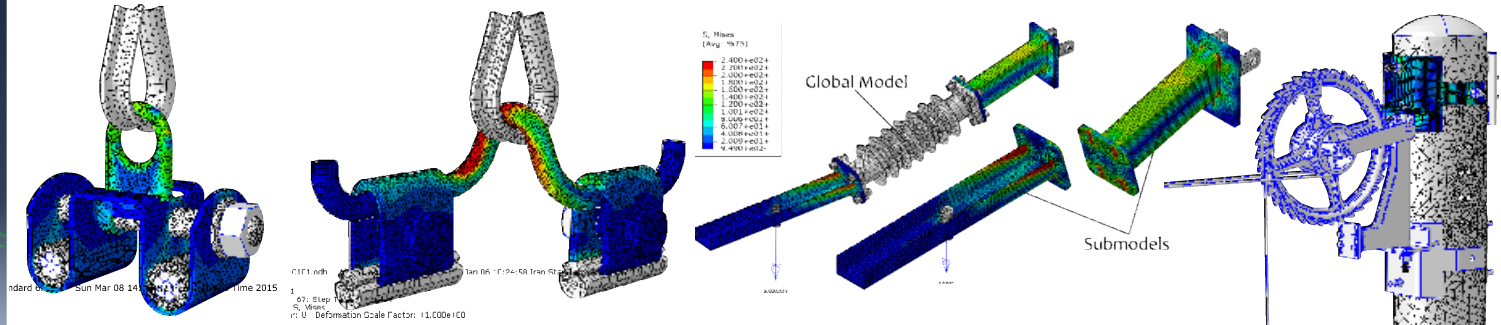
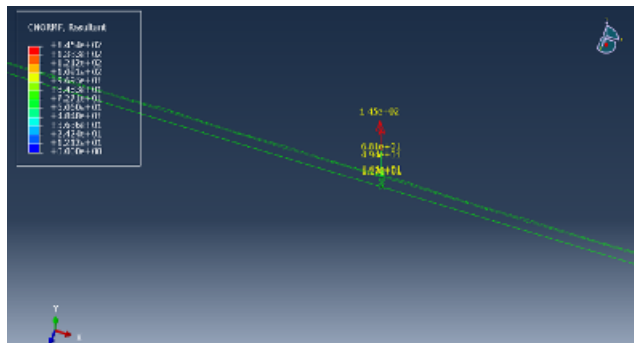

Alucast Iran Co.

Engineering Units

Design Unit

The main activities of design team are; designing electrification system formation of metro trolleybus, distribution and transmission networks and providing administrative and operational maps. Designing department is aim to compete with oversea competitor by the use of scientific knowledge and advanced software with designing ideal products. All of the equipment, fittings, structures and designed formations are simulated and assembled in software environment in accordance to project terms to conduct studies on the project in order to provide required implementation for production and installation team.

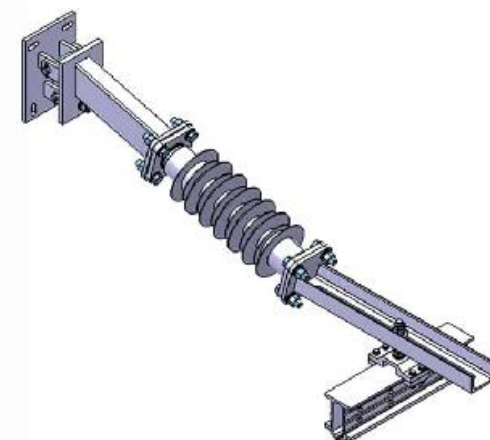
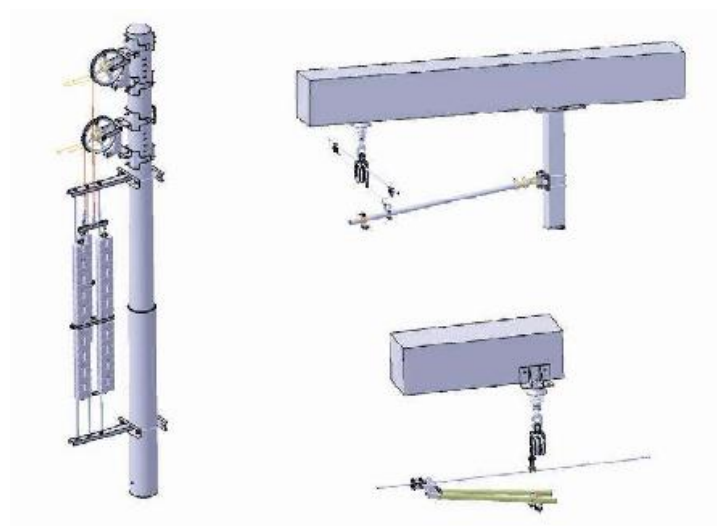
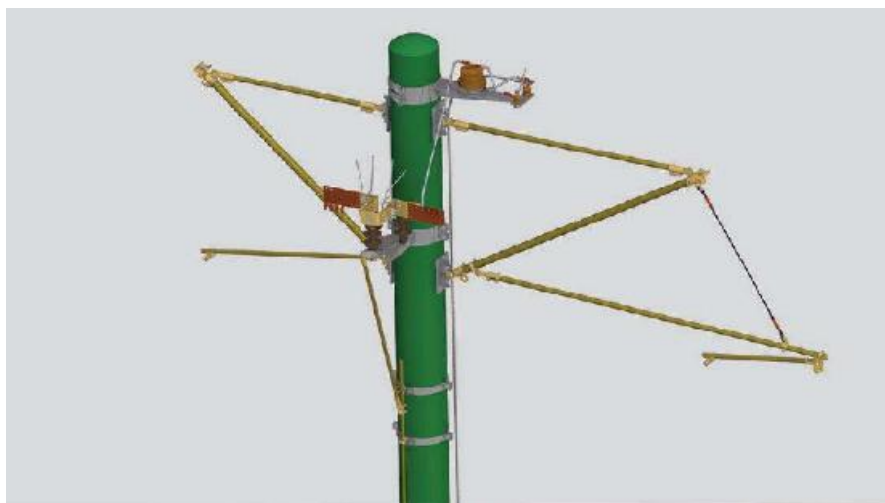

Engineering Units

Metallurgy Unit

The Materials Engineering Unit's scope involves designing, production and selection of iron alloys (Cast Iron-Steel) and non-iron alloys (Aluminum Alloys-Copper-Zinc), which is achieved relying on the knowledge and experience of dedicated specialists. Related softwares as well as control and testing methods are used in manufacturing of a typical equipment. The Materials Engineering Unit is also capable of manufacturing products with optimized mechanical, physical and metallurgical properties. Some of the unit's capabilities are as follow:

1. Simulation of casting products using ProCast software with the ability of casting cast iron (Gray and Ductile), copper alloys (Brass and Bronze Specially Aluminum Bronze), aluminum and zinc alloy (Zamak).
2. Element analysis of iron-based and non-iron-based manufactured products using spectrometry (Quanto).
3. Metallography of all iron and non-iron products.
 - 3-1. Steels
 - 3-2. Cast Iron
 - 3-3. Aluminum Alloys
 - 3-4. Copper Alloys - Aluminum Bronze
4. Mechanical tests including tensile-impact testing and hardness test with Brinell and Rockwell methods.

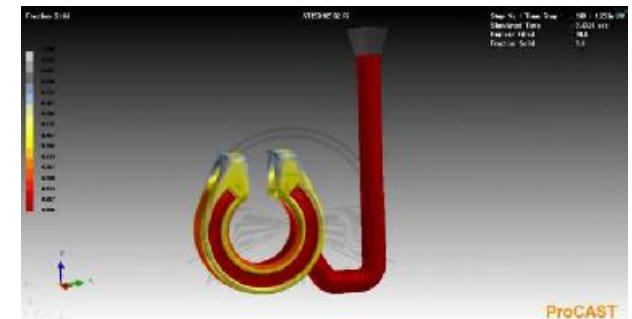
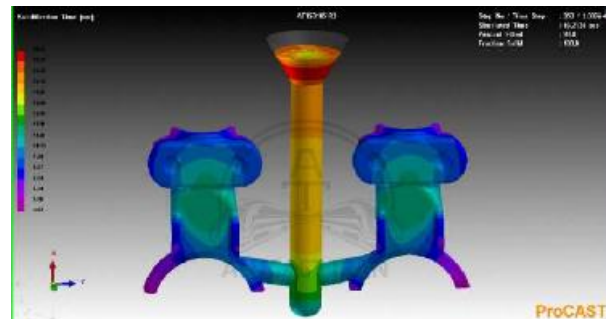

Alucast Iran Co.

Engineering Units



QC Unit

By taking advantages of an expert group, the quality control unit of Alucast Iran Co. performs quality control operations on all of the produced equipment in various stages of production, according to design standards. The quality control is performed using precise measuring instrumentations, which are periodically inspected and calibrated in authorized organizations.



Alucast Iran Co.

Engineering Units

Electrical Simulation Software

Electrical simulator software of Alucast Iran electrical team is a local software owned by company that is designed in a way to be able to simulate performance of intercity fast trains, urban trains, and subway. Intended software is able to calculate and simulate autotransformer networks, DC networks and simple networks. Dimension and length of route do not affect the performance of the software and also, software is able to distinguish amount different situations route and environment (Tunnel or Open Cuts), speed and acceleration, type of locomotive and number of wagons to perform simulations. System elements calculations respect to electrifications system even in combined systems is one of the triticale benefits of the Alucast Iran electrical simulator software.

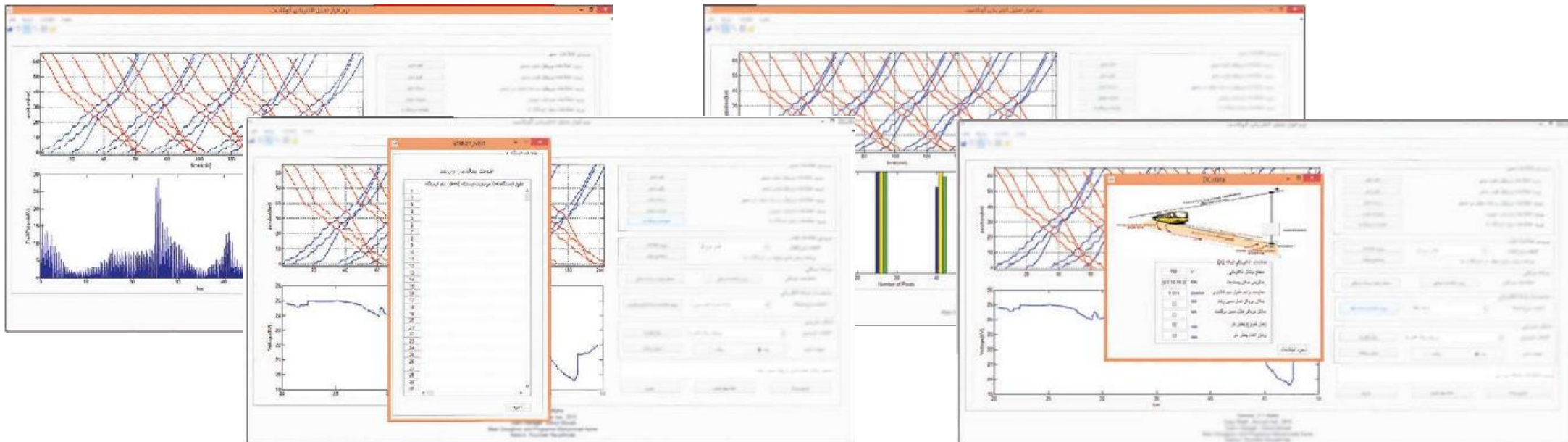

Alucast Iran Co.

Engineering Units



Mechanical Software

Alucast's catenary design software is a powerful and complete software for automatic design of overhead contact line and checking the correctness or incorrectness of a designed catenary design. It designs the optimized catenary design according to environment condition (maximum and minimum temperature, wind speed, etc.), line's topography (route radius, position of poles, span length, etc.) and overhead contact line specifications (stagger, tensile force for contact and catenary wires, geometry of the array, etc.). The software is able to survey all necessary parameters and international standards in the field of electrical railway for an accomplished catenary design in terms of overhead contact line and monitoring of the all technical errors.

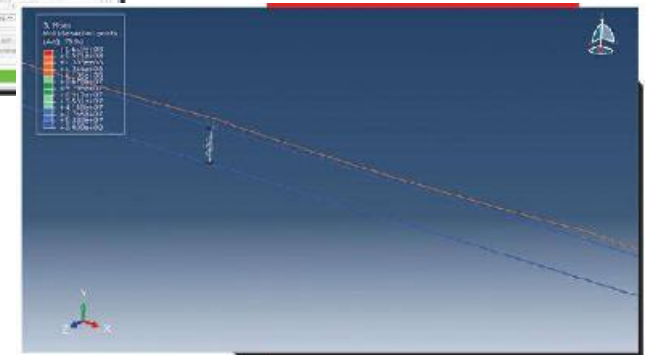
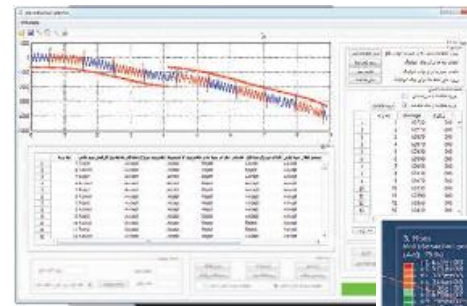
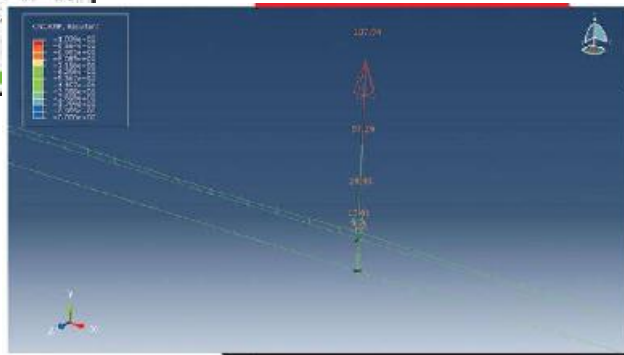
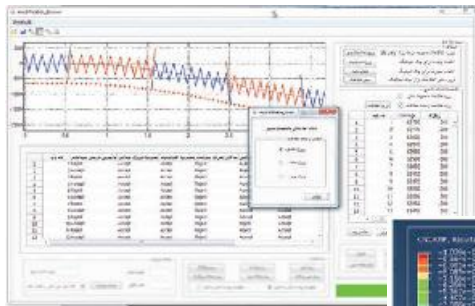

Alucast Iran Co.

Engineering Units



Electrification Plan (Spotting)

According to the criteria's stated in EN50119 and the related standards and also the help of educated and experienced experts a practical tool is developed to check the feasibility of the catenary design regarding the static criteria's.

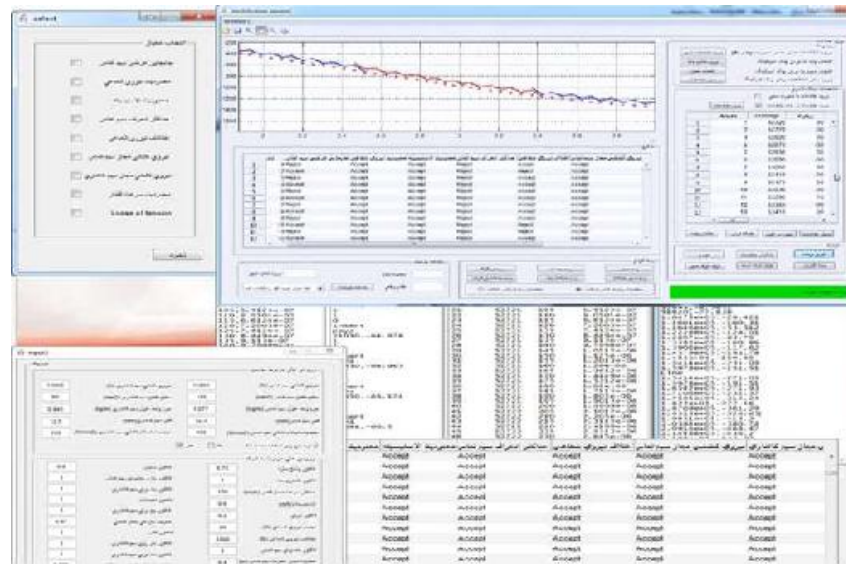

Alucast Iran Co.

Design Projects



Electrification of the Golshahr- Hashtgerd Tehran metro line 5 extension

- EPC project Design, manufacture of fittings, supervision of installation
- 2*25KM-length, 2*25KV- voltage level, 120 KM/H- Speed



Electrification of the Shiraz metro line 1 extension

- EPC project Design, manufacture of fittings, supervision of installation
- 2*12KM-length, 1500V- voltage level, 80 KM/H- Speed



Electrification of the Mashhad metro line 1 extension to airport

- EPC project Design, manufacture of fittings, supervision of installation
- 2*5KM-length, 750 Volts- voltage level, 80 KM/H- Speed

Projects

Alucast Iran Co.

Installation Projects



Electrification of the Golshahr- Hashtgerd Tehran metro line 5 extension

- EPC project Design, manufacture of fittings, supervision of installation
- 2*25KM-length, 2*25KV- voltage level, 120 KM/H- Speed



Electrification of the Shiraz metro line 1 extension

- EPC project Design, manufacture of fittings, supervision of installation
- 2*12KM-length, 1500V- voltage level, 80 KM/H- Speed

Projects

Alucast Iran Co.

Manufacturing and supply Projects

Projects



Electrification of the Golshahr- Hashtgerd Tehran metro line 5 extension

- Manufacture of fittings



Shiraz metro Phase 1

- Manufacture of fittings- 15 types



Mashhad metro Phase 1- reinforcement

- Manufacture of fittings - 250 types



Tabriz metro Phase 1

- Manufacture of fittings - 12 types



Electrification of the Tabriz- Azarshahr railway

- Manufacture of fittings

Alucast Iran Co.

Samples of manufactured components

OCS and electric bus

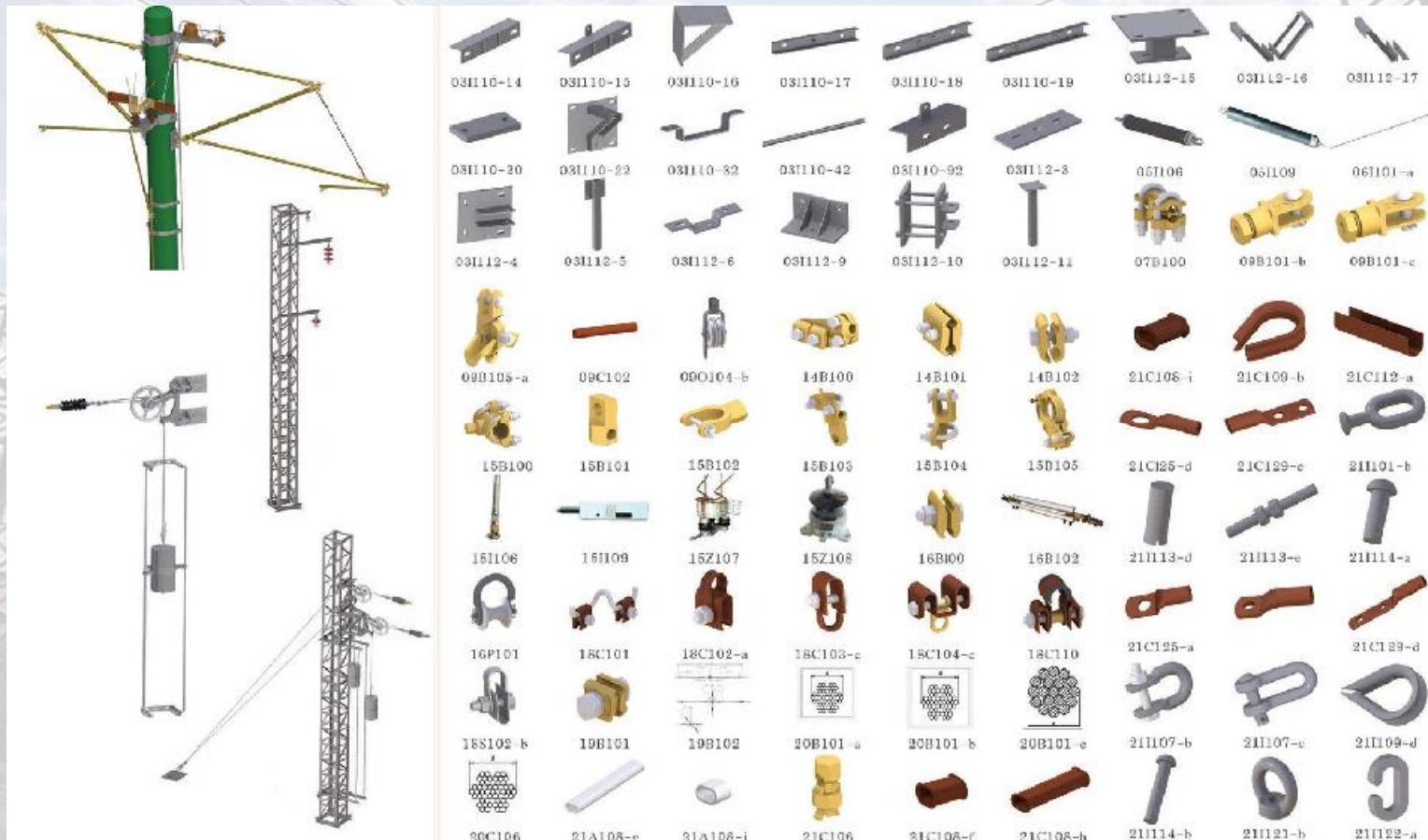

Alucast Iran Co.

Samples of manufactured components

Rigid overhead conductor rail system



ATR14

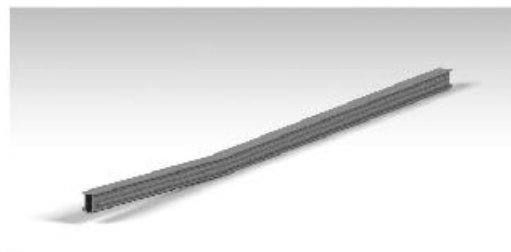

ATR11



ATR04

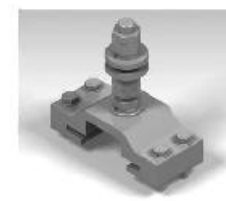

ATR05



ATR01-01



ATR02-01



ATR03-01



ATR04

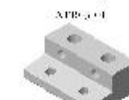

ATR05-02



ATR05-03



ATR05-05

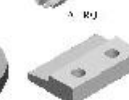

ATR05-07



ATR15

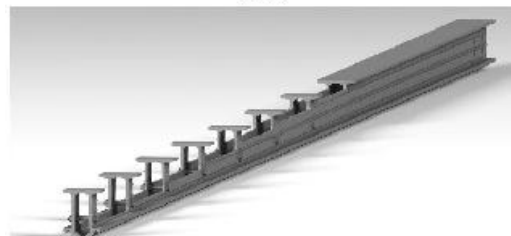

ATR12



ATR07



ATR08



ATR08-01



ATR09-01



ATR09-01



ATR09



ATR09



ATR08



ATR10-01



ATR11-01



ATR11-A

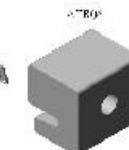

ATR10-01



ATR13



ATR12



ATR14-01



ATR14-01



ATR14-01

Alucast Iran Co.

Installation Procedures



Electromechanical installation teams

The group of Alucast Companies benefits from several electrical and mechanical installation teams specialized in different areas of electrical power network and equipment. The installation activities include installation of distribution network equipment as well as the often complicated mechanical equipment of overhead catenary systems with special electric performances in voltages of 750 to 25000 Volts. Relying on the experiences of the installation staff in assembling of diverse low and mid voltage electrical equipment such as circuit breakers, protection facilities, overhead and underground cabling, switchgears, switchboards, grid connection equipment, etc., Alucast Iran is ready for vast participation in installation activities of distribution network systems, low voltage systems, OCS network equipment, mid-voltage power facilities for industrial centers, and small-scale power plant and substation installations.



Alucast Iran Company

Thinks beyond borders

